

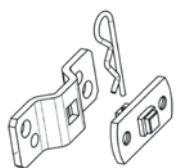

**Motori tubolari**  
*Tubular motors*

**CDE-R - CDE 45 con manovra di soccorso / with manual override**



**2204115**



**Staffa con perno quadrato completa di culla.**  
**Interasse 48/60 mm (solo per motori con manovra di soccorso)**  
*Bracket with square pin center - to - center*  
*distance 48 / 60 mm (only for motors with manual override)*

CONF. 5 PZ / PACK. 5 PCS

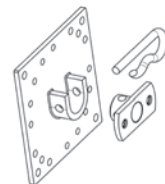

**2204124**



**Staffa 100 x 100 con sella per perno rotondo a due posizioni**  
*100 x 100 bracket with two positions round pin*

CONF. 5 PZ / PACK. 5 PCS

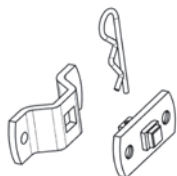

**2204118**



**Staffa con perno quadrato completa di culla.**  
**Interasse 48 mm e fori filettati (solo per motori con manovra di soccorso)**  
*Bracket with square pin threaded holes with center - to center*  
*distance 48 mm (only for motors with manual override)*

CONF. 5 PZ / PACK. 5 PCS

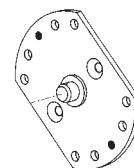

**2200010**



**Staffa con perno di supporto centrale**  
*Revolving bracket with central support pivot*

CONF. 5 PZ / PACK. 5 PCS

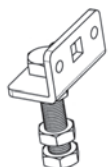

**2204121**



**Staffa con perno Ø 10 per innesto diretto su murature già esistenti**  
*Bracket with Ø 10 threading pin for the direct clutch on the existing clamp*

CONF. 5 PZ / PACK. 5 PCS

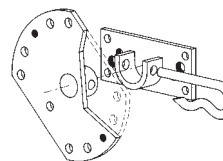

**2200003**



**Staffa orientabile con perno rotondo a due posizioni e relativa sella**  
*Revolving bracket with two positions round pivot*

CONF. 5 PZ / PACK. 5 PCS

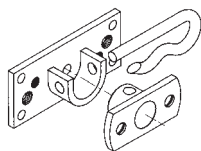

**2204147**



**Staffa con perno rotondo a due posizioni**  
*Bracket with two positions round pin*

CONF. 5 PZ / PACK. 5 PCS

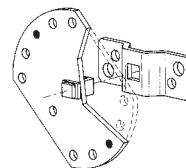

**2204051**



**Staffa orientabile con perno quadrato e relativa sella**  
*Revolving bracket with square pin and housing*

CONF. 5 PZ / PACK. 5 PCS

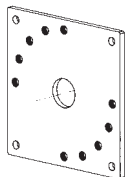

**2200043**



**Staffa 100 x 100**  
*100 x 100 bracket plate*

CONF. 5 PZ / PACK. 5 PCS

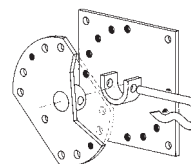

**2200076**



**Staffa orientabile con perno rotondo a due posizioni e sella su 100 x 100**  
*Revolving bracket with two positions round pivot and 100 x 100 housing*

CONF. 5 PZ / PACK. 5 PCS



**Motori tubolari**  
*Tubular motors*

**CDE-R - CDE 45 con manovra di soccorso / with manual override**



**2204152**



**Staffa regolabile verticalmente con perno rotondo a due posizioni**  
*Adjustable bracket with two positions round pin*

CONF. 5 PZ / PACK. 5 PCS

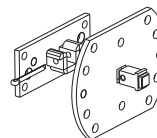

**2204211**



**Staffa regolabile verticalmente con perno quadrato a due posizioni**  
*Revolving bracket with two positions square pin*

CONF. 5 PZ / PACK. 5 PCS

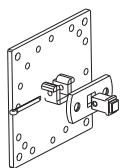

**2204200**



**Staffa 100x100 per perno quadrato**  
*100 x 100 bracket with square pin*

CONF. 5 PZ / PACK. 5 PCS

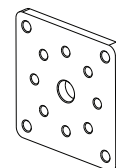

**2200161**



**Staffa quadrata interasse 48 box**  
*Square bracket 48 center to center box*

CONF. 5 PZ / PACK. 5 PCS

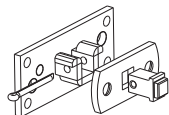

**2204204**



**Staffa con culla per perno quadrato. Interasse 48/60 mm**  
*Bracket with seat for square pin interaxis 48/60 mm*

CONF. 5 PZ / PACK. 5 PCS

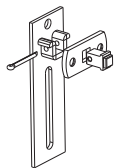

**2204208**



**Staffa regolabile verticalmente con perno quadrato**  
*Adjustable bracket with square pin*

CONF. 5 PZ / PACK. 5 PCS

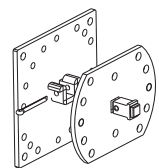

**2204210**



**Staffa orientabile con perno quadrato a due posizioni e sella su 100x100**  
*Revolving bracket with two positions square pin and 100 x 100 housing*

CONF. 5 PZ / PACK. 5 PCS

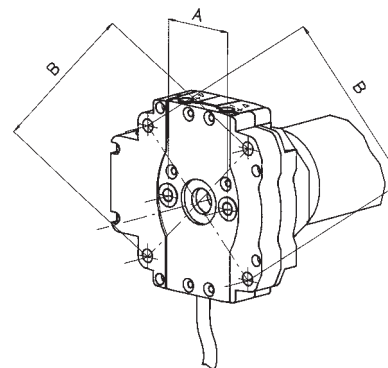

**Interasse A: da utilizzare per fissaggio motori con coppia fino a 50Nm.**

*Interaxis distance A: to fix motors with nominal torque up to 50 Nm.*

**Interasse B: da utilizzare tassativamente per i motori con coppia  $\geq 80$ Nm.**

*Interaxis distance B: to fix motors with nominal torque  $\geq 80$ Nm.*